

SWAGE MOUNT

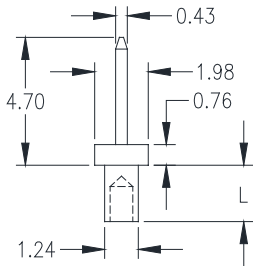

Part Number	Finish	DIM. L	Mtg. Hole
mPIN001-Sw43G-1	GOLD	1.30mm	Ø1.32mm
mPIN001-Sw43T-1	TIN	1.30mm	
mPIN001-Sw43G-2	GOLD	2.08mm	
mPIN001-Sw43T-2	TIN	2.08mm	
mPIN001-Sw43G-3	GOLD	2.87mm	
mPIN001-Sw43T-3	TIN	2.87mm	
mPIN001-Sw43G-4	GOLD	3.68mm	
mPIN001-Sw43T-4	TIN	3.68mm	

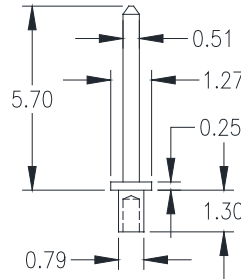

Part Number	Finish	Mtg. Hole
mPIN009-Sw51G-1	GOLD	Ø0.89mm
mPIN009-Sw51T-1	TIN	

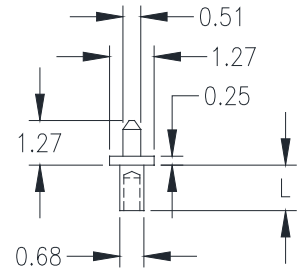

Part Number	Finish	DIM. L	Mtg. Hole
mPIN010-Sw51G-1	GOLD	1.30mm	Ø0.78mm
mPIN010-Sw51T-1	TIN	1.30mm	
mPIN010-Sw51G-2	GOLD	2.08mm	
mPIN010-Sw51T-2	TIN	2.08mm	

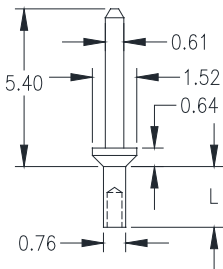

Part Number	Finish	DIM. L	Mtg. Hole
mPIN011-Sw61G-1	GOLD	1.19mm	Ø0.89mm
mPIN011-Sw61T-1	TIN	1.19mm	
mPIN011-Sw61G-2	GOLD	1.98mm	
mPIN011-Sw61T-2	TIN	1.98mm	
mPIN011-Sw61G-3	GOLD	2.79mm	
mPIN011-Sw61T-3	TIN	2.79mm	
mPIN011-Sw61G-4	GOLD	3.58mm	
mPIN011-Sw61T-4	TIN	3.58mm	

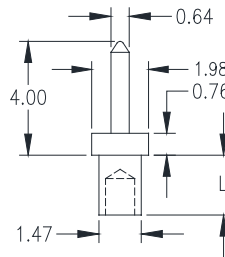

Part Number	Finish	DIM. L	Mtg. Hole
mPIN012-Sw64G-1	GOLD	1.57mm	Ø1.57mm
mPIN012-Sw64T-1	TIN	1.57mm	
mPIN012-Sw64G-2	GOLD	2.39mm	
mPIN012-Sw64T-2	TIN	2.39mm	
mPIN012-Sw64G-3	GOLD	3.18mm	
mPIN012-Sw64T-3	TIN	3.18mm	
mPIN012-Sw64G-4	GOLD	3.96mm	
mPIN012-Sw64T-4	TIN	3.96mm	

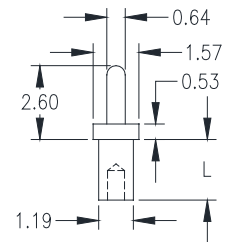

Part Number	Finish	DIM. L	Mtg. Hole
mPIN013-Sw64G-1	GOLD	1.30mm	Ø1.32mm
mPIN013-Sw64T-1	TIN	1.30mm	
mPIN013-Sw64G-2	GOLD	2.08mm	
mPIN013-Sw64T-2	TIN	2.08mm	
mPIN013-Sw64G-3	GOLD	2.87mm	
mPIN013-Sw64T-3	TIN	2.87mm	
mPIN013-Sw64G-4	GOLD	3.68mm	
mPIN013-Sw64T-4	TIN	3.68mm	

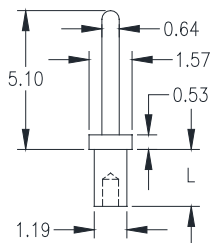

Part Number	Finish	DIM. L	Mtg. Hole
mPIN014-Sw64G-1	GOLD	1.30mm	Ø1.32mm
mPIN014-Sw64T-1	TIN	1.30mm	
mPIN014-Sw64G-2	GOLD	2.08mm	
mPIN014-Sw64T-2	TIN	2.08mm	
mPIN014-Sw64G-3	GOLD	2.87mm	
mPIN014-Sw64T-3	TIN	2.87mm	
mPIN014-Sw64G-4	GOLD	3.68mm	
mPIN014-Sw64T-4	TIN	3.68mm	

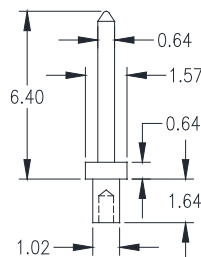

Part Number	Finish	Mtg. Hole
mPIN015-Sw64G-1	GOLD	Ø1.09mm
mPIN015-Sw64T-1	TIN	

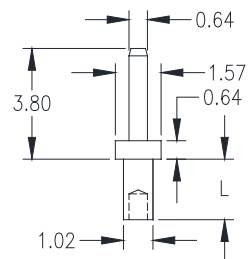

Part Number	Finish	DIM. L	Mtg. Hole
mPIN016-Sw64G-1	GOLD	1.30mm	Ø1.09mm
mPIN016-Sw64T-1	TIN	1.30mm	
mPIN016-Sw64G-2	GOLD	2.08mm	
mPIN016-Sw64T-2	TIN	2.08mm	
mPIN016-Sw64G-3	GOLD	2.87mm	
mPIN016-Sw64T-3	TIN	2.87mm	

SWAGE MOUNT

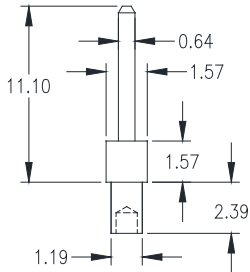

Part Number	Finish	Mtg. Hole
mPIN017-Sw64G-2	GOLD	Ø1.32mm
mPIN017-Sw64T-2	TIN	

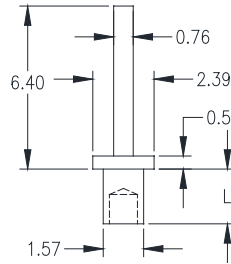

Part Number	Finish	DIM. L	Mtg. Hole
mPIN018-Sw76G-1	GOLD	1.30mm	Ø1.70mm
mPIN018-Sw76T-1	TIN	2.08mm	
mPIN018-Sw76G-2	GOLD		
mPIN018-Sw76T-2	TIN	2.87mm	
mPIN018-Sw76G-3	GOLD		
mPIN018-Sw76T-3	TIN		

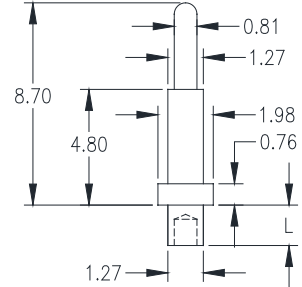

Part Number	Finish	DIM. L	Mtg. Hole
mPIN020-Sw81G-1	GOLD	1.30mm	Ø1.32mm
mPIN020-Sw81T-1	TIN	2.08mm	
mPIN020-Sw81G-2	GOLD		
mPIN020-Sw81T-2	TIN		

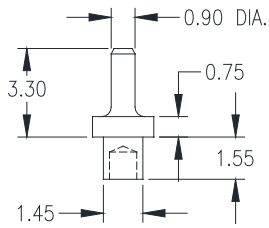

Part Number	Finish	Mtg. Hole
mPIN021-Sw89G-1	GOLD	Ø1.57mm
mPIN021-Sw89T-1	TIN	

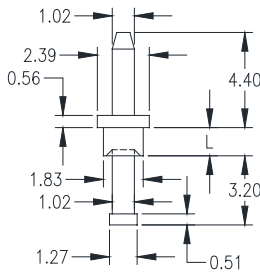

Part Number	Finish	DIM. L	Mtg. Hole
mPIN022-Sw102G-1	GOLD	1.30mm	Ø1.93mm
mPIN022-Sw102T-1	TIN	2.08mm	
mPIN022-Sw102G-2	GOLD		
mPIN022-Sw102T-2	TIN	2.87mm	
mPIN022-Sw102G-3	GOLD		
mPIN022-Sw102T-3	TIN	3.68mm	
mPIN022-Sw102G-4	GOLD		
mPIN022-Sw102T-4	TIN		

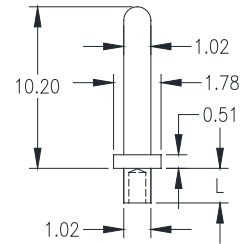

Part Number	Finish	DIM. L	Mtg. Hole
mPIN023-Sw102G-1	GOLD	1.30mm	Ø1.09mm
mPIN023-Sw102T-1	TIN	2.08mm	
mPIN023-Sw102G-2	GOLD		
mPIN023-Sw102T-2	TIN		

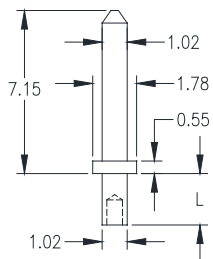

Part Number	Finish	DIM. L	Mtg. Hole
mPIN024-Sw102G-1	GOLD	1.30mm	Ø1.09mm
mPIN024-Sw102T-1	TIN	2.08mm	
mPIN024-Sw102G-2	GOLD		
mPIN024-Sw102T-2	TIN	2.87mm	
mPIN024-Sw102G-3	GOLD		
mPIN024-Sw102T-3	TIN		

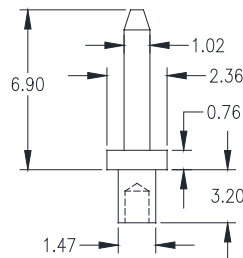

Part Number	Finish	Mtg. Hole
mPIN025-Sw102G-3	GOLD	Ø1.57mm
mPIN025-Sw102T-3	TIN	

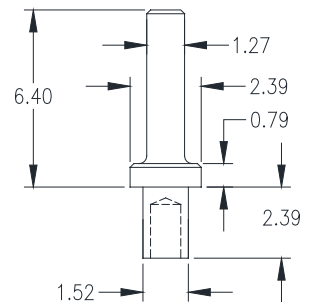

Part Number	Finish	Mtg. Hole
mPIN028-Sw127G-2	GOLD	Ø1.63mm
mPIN028-Sw127T-2	TIN	

SWAGE MOUNT

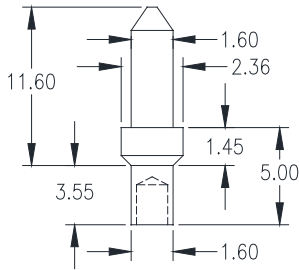

Part Number	Finish	Mtg. Hole
mPIN029-Sw160G-2	GOLD	Ø1.70mm
mPIN029-Sw160T-2	TIN	

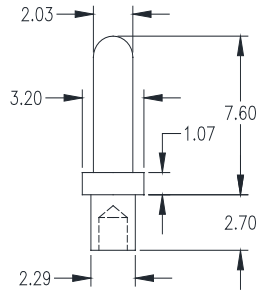

Part Number	Finish	Mtg. Hole
mPIN030-Sw203G-2	GOLD	Ø2.38mm
mPIN030-Sw203T-2	TIN	

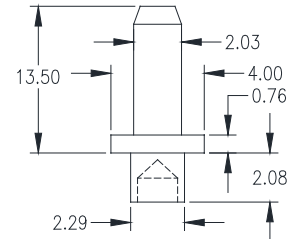

Part Number	Finish	Mtg. Hole
mPIN031-Sw203G-2	GOLD	Ø2.38mm
mPIN031-Sw203T-2	TIN	

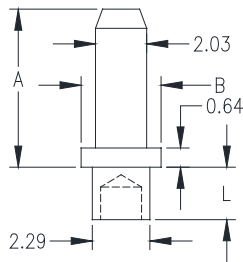

Part Number	Finish	DIM. L	Mtg. Hole
mPIN032-Sw200G-1	GOLD	1.30mm	Ø2.38mm
mPIN032-Sw200T-1	TIN	1.30mm	
mPIN032-Sw200G-2	GOLD	2.39mm	
mPIN032-Sw200T-2	TIN	2.39mm	
mPIN032-Sw200G-3	GOLD	3.18mm	
mPIN032-Sw200T-3	TIN	3.18mm	
mPIN032-Sw200G-4	GOLD	3.96mm	
mPIN032-Sw200T-4	TIN	3.96mm	

SOLDER MOUNT

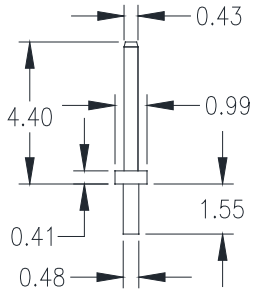

Part Number	Finish	Mtg. Hole
mPIN002-So43G-1	GOLD	Ø0.56mm
mPIN002-So43T-1	TIN	

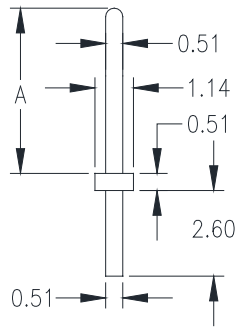

Part Number	Finish	DIM. L	Mtg. Hole
mPIN008A-So51G-3	GOLD	6.35mm	Ø0.61mm
mPIN008A-So51T-3	TIN		
mPIN008B-So51G-3	GOLD	10.8mm	
mPIN008B-So51T-3	TIN		

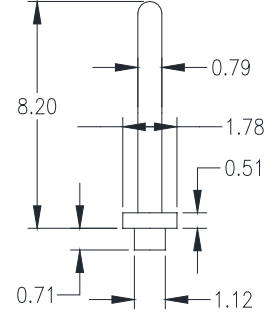

Part Number	Finish	Mtg. Hole
mPIN019-So79G-1	GOLD	Ø1.09mm
mPIN019-So79T-1	TIN	

PRESS FIT

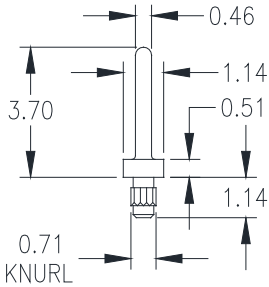

Part Number	Finish	Mtg. Hole
mPIN003-Pf46G-1	GOLD	Ø0.66mm
mPIN003-Pf46T-1	TIN	

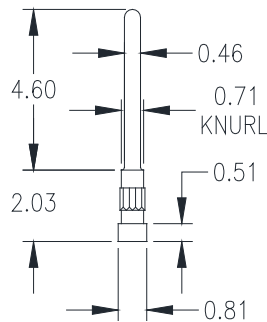

Part Number	Finish	Mtg. Hole
mPIN004-Pf46G-2	GOLD	Ø0.66mm
mPIN004-Pf46T-2	TIN	

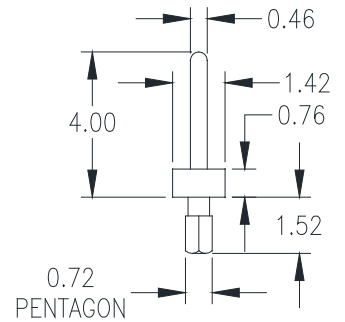

Part Number	Finish	Mtg. Hole
mPIN005-Pf46G-2	GOLD	Ø0.66mm
mPIN005-Pf46T-2	TIN	

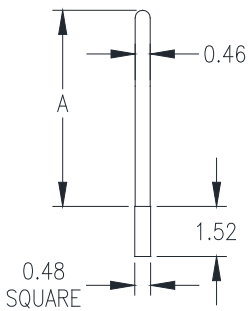

Part Number	Finish	DIM. L	Mtg. Hole
mPIN006A-Pf46G-2	GOLD	6.17mm	Ø0.56mm
mPIN006A-Pf46T-2	TIN		
mPIN006A-Pf46G-2	GOLD	3.56mm	
mPIN006A-Pf46T-2	TIN		

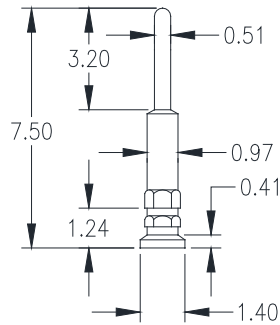

Part Number	Finish	Mtg. Hole
mPIN007-Pf102G-2	GOLD	Ø1.01mm
mPIN007-Pf102T-2	TIN	

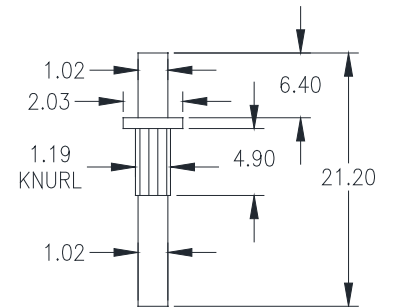

Part Number	Finish	Mtg. Hole
mPIN026-Pf102	N/A	Ø1.09mm