

**D-SUB CONNECTOR  
(WIRE TYPE)**

---

# D-SUBMINIATURE CLASSIFICATION



\* RIGHT ANGLE D-SUB( Pa )  
DB 1XX SERIES

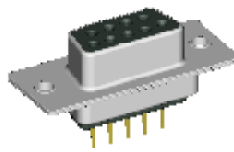

\* STRAIGHT D-SUB( P )  
DB 2XX SERIES

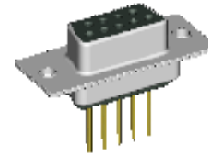

\* WIRING D-SUB( W )  
DB 3XX SERIES

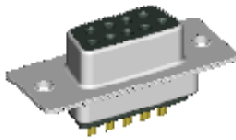

\* SOLDER CUP D-SUB( Sc )  
DB 4XX SERIES

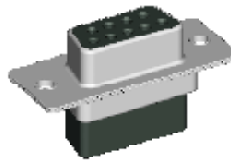

\* CRIMP D-SUB( Cr )  
DB 5XX SERIES

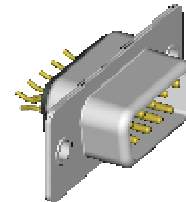

\* STRADDLE D-SUB( Ste )  
DB 6XX SERIES

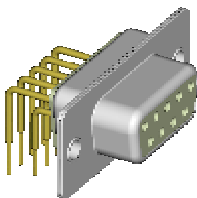

\* MACHINE PIN D-SUB  
DB 9XX SERIES

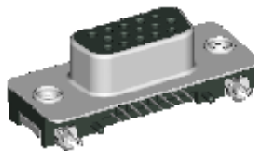

\* HIGH DENSITY D-SUB  
HDB SERIES

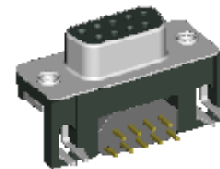

\* EMI D- SUB  
EDB & EHDB SERIES

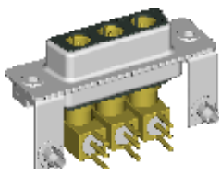

\* COMBO D-SUB  
CDB SERIES



\* IDC D-SUB  
IDB SERIES

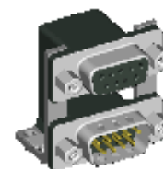

\* STACK D-SUB  
SDB SERIES

NOTE : SOME SIZES, STYLES AND OPTION ARE NON-STANDARD, NON-CANCELLABLE, NON-RETURNABLE

# DB1XX SERIES MOUNTING OPTIONS

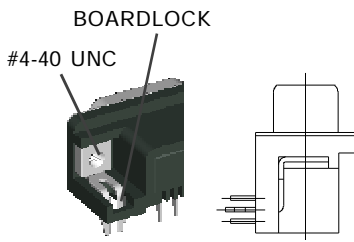

**a TYPE**  
WITH #4-40UNC THREAD INSERT  
GROUNDING BRACKET &  
BOARDLOCK

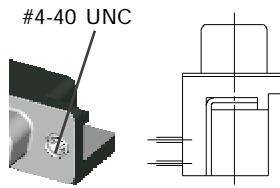

**b TYPE**  
WITH #4-40UNC THREAD INSERT  
GROUNDING BRACKET

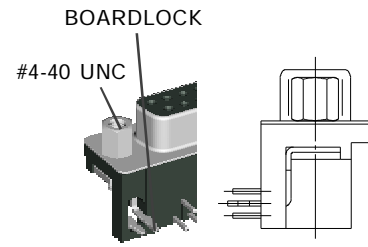

**c TYPE**  
WITH FIXED #4-40UNC HEX NUT  
GROUNDING BRACKET &  
BOARDLOCK

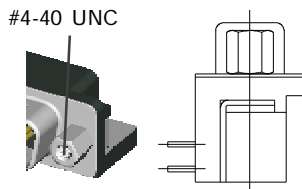

**d TYPE**  
WITH FIXED #4-40UNC HEX NUT  
GROUNDING BRACKET

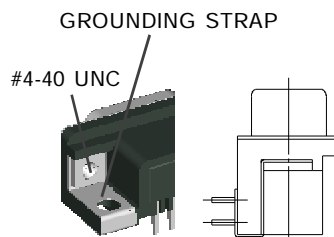

**e TYPE**  
WITH #4-40UNC THREAD INSERT  
GROUNDING STRAP

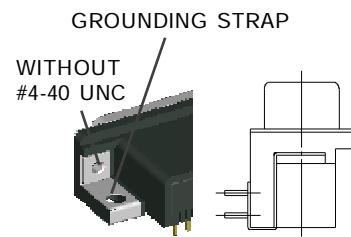

**en TYPE**  
WITHOUT #4-40UNC THREAD INSERT  
WITH GROUNDING STRAP

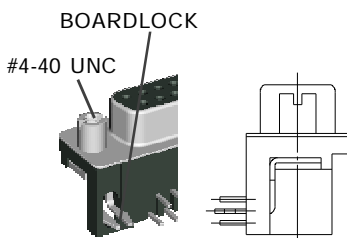

**rc TYPE**  
WITH FIXED #4-40UNC ROUND NUT  
GROUNDING BRACKET &  
BOARDLOCK

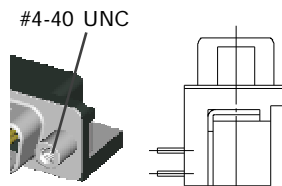

**rd TYPE**  
WITH FIXED #4-40UNC ROUND NUT  
GROUNDING BRACKET

NOTE : SOME SIZES, STYLES AND OPTION ARE NON-STANDARD, NON-CANCELLABLE, NON-RETURNABLE

## DB 2XX SERIES MOUNTING OPTIONS

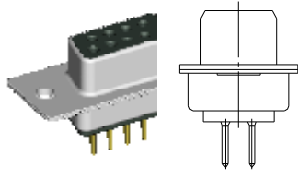

H TYPE  
WITH MOUNTING HOLE ONLY

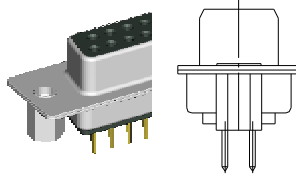

I TYPE  
WITH #4-40UNC HEX NUT  
IN THE REAR OF THE SHELL

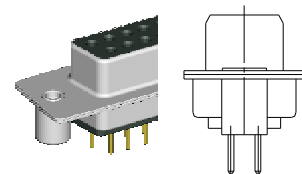

J TYPE  
WITH #4-40UNC ROUND NUT  
IN THE REAR OF THE SHELL

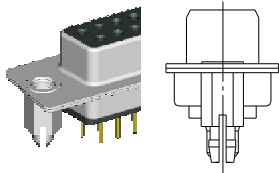

K TYPE  
WITH #4-40UNC IN THE REAR SHELL  
USE RIVET AS BOARDLOCK

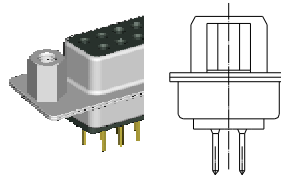

L TYPE  
WITH #4-40UNC HEX NUT  
IN THE FRONT OF THE SHELL

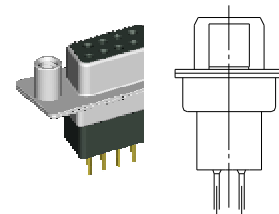

M TYPE  
WITH #4-40UNC ROUND NUT  
IN THE FRONT OF THE SHELL

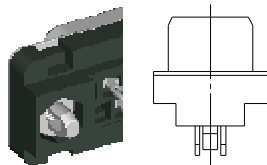

P TYPE  
WITH #4-40UNC IN THE REAR SHELL  
USE PRESS FIT BOARDLOCK

NOTE : SOME SIZES, STYLES AND OPTION ARE NON-STANDARD, NON-CANCELLABLE, NON-RETURNABLE

# D-SUB CONNECTOR PART NO. INFORMATION

**DB**    **XXX** - **X**    **X**    **XX**    **GX**    -    **X**    **X**

D-SUB  
CONNECTOR

GENDER

M: MALE  
F: FEMALE

NO. OF CONTACT

09,15,25,37,50

PCB or TERMINAL TYPE

Pa: RIGHT ANGLE TYPE  
P: STRAIGHT TYPE  
W: WIRE TYPE  
Sc: SOLDER CUP TYPE  
Cr: CRIMP TYPE  
Ste: STRADDLE MOUNT TYPE

BOARDLOCK OPTION

X: WITHOUT PRONG BOARD  
2: 2 PRONG BOARD LOCK  
4: 4 PRONG BOARD LOCK

CONTACT PLATING OPTION

Gf: GOLD FLASH  
G30: 30u" GOLD PLATING  
Gft: GOLD FLASH ON CONTACT, TIN PLATED ON SOLDER TAIL  
G15t: 15u" GOLD ON CONTACT, TIN PLATED ON SOLDER TAIL  
G30t: 30u" GOLD ON CONTACT, TIN PLATED ON SOLDER TAIL

SERIES NO.

1XX: RIGHT ANGLE TYPE  
-100: FOOTPRINT= 8.08 mm  
-120: FOOTPRINT= 14.84 mm  
-121: FOOTPRINT= 8.00 mm  
-131: FOOTPRINT= 1.60 mm  
-132: FOOTPRINT= 1.20 mm  
-160: FOOTPRINT= 5.08 mm

2XX: STRAIGHT TYPE  
-200: LENTH= 4.85 mm  
-210: LENTH= 5.00 mm  
-250: PRESS FIT PCB TYPE

3XX: WIRE TYPE  
-300: LENTH= 10.50 mm  
-310: LENTH= 13.50 mm  
-320: LENTH= 17.50 mm

4XX: SOLDER CUP TYPE  
- 400

5XX: CRIMP TYPE  
- 500

6XX: STRADDLE MOUNT TYPE  
-600

9XX: MACHINE PIN TYPE  
-900: FOOTPRINT= 8.00 mm  
-910: FOOTPRINT= 10.20 mm  
-930: FOOTPRINT= 8.19 mm  
-931: FOOTPRINT= 10.39 mm

MOUNTING TYPE

FOR RIGHT ANGLE TYPE

a :WITH #4-40UNC THREAD INSERT GROUNDING BRACKET & BOARDLOCK  
an: WITHOUT #4-40UNC THREAD INSERT

GROUNDING BRACKET & BOARDLOCK

b: WITH #4-40UNC THREAD INSERT GROUNDING BRACKET & BOARDLOCK  
c: WITH FIXED #4-40UNC HEX NUT GROUNDING BRACKET & BOARDLOCK

d: WITH FIXED #4-40UNC HEX NUT GROUNDING BRACKET

e : WITH #4-40UNC THREAD INSERT GROUNDING STRAP

en: WITHOUT #4-40UNC THREAD INSERT WITH GROUNDING STRAP

rc: WITH FIXED #4-40UNC ROUND NUT GROUNDING BRACKET & BOARDLOCK

rd: WITH FIXED #4-40UNC ROUND NUT GROUNDING BRACKET

FOR STRAIGHT TYPE

H: WITH MOUNTING HOLE ONLY

I: WITH #4-40UNC HEX NUT IN THE REAR OF THE SHELL

J: WITH #4-40UNC ROUND NUT IN THE REAR OF THE SHELL

K: WITH #4-40UNC IN THE REAR SHELL USE RIVET AS BOARDLOCK

L: WITH #4-40UNC HEX NUT IN THE FRONT OF THE SHELL

M: WITH #4-40UNC ROUND NUT IN THE FRONT OF THE SHELL

JP: WITH #4-40UNC ROUND NUT WITH PLASTIC INSERT

IN THE REAR OF THE SHELL

P: WITH #4-40UNC IN THE REAR SHELL USE PRESS FIT BOARDLOCK

NOTE : SOME SIZES, STYLES AND OPTION ARE NON-STANDARD, NON-CANCELLABLE, NON-RETURNABLE

# D-SUB 3X0 SERIES *MOUNTING TYPE H* WIRING TYPE - W

## MALE

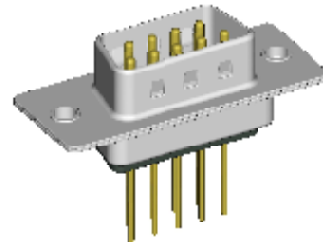
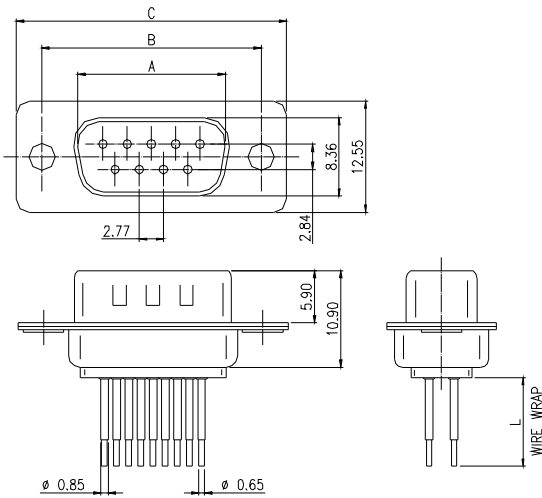

MODEL NO.	NO.OF CONTACTS (SHELL SIZE)	DIMENSION		
		A	B	C
DB3X0-WM09GX-H	9P	16.92	24.99	30.81
DB3X0-WM15GX-H	15P	25.25	33.32	39.14
DB3X0-WM25GX-H	25P	38.96	47.04	53.04
DB3X0-WM37GX-H	37P	54.42	63.50	69.32

L - WIRE WRAP LENGTH OPTIONS	
DB300	10.50
DB310	13.50
DB320	17.50

## FEMALE

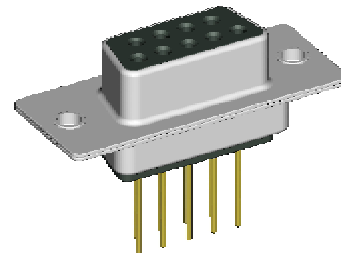
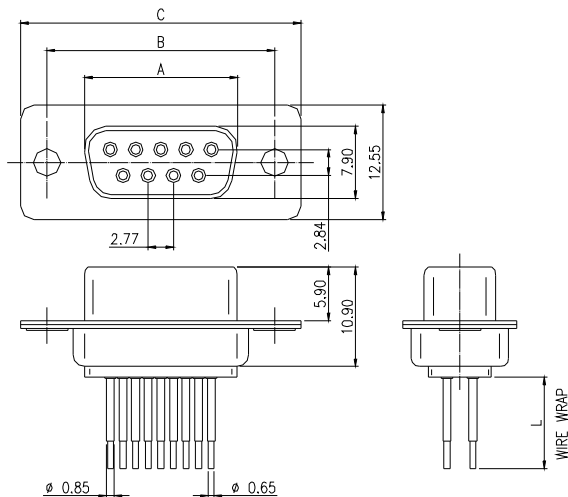

MODEL NO.	NO.OF CONTACTS (SHELL SIZE)	DIMENSION		
		A	B	C
DB3X0-WF09GX-H	9P	16.33	24.99	30.81
DB3X0-WF15GX-H	15P	24.66	33.32	39.14
DB3X0-WF25GX-H	25P	38.38	47.04	53.04
DB3X0-WF37GX-H	37P	54.84	63.50	69.32

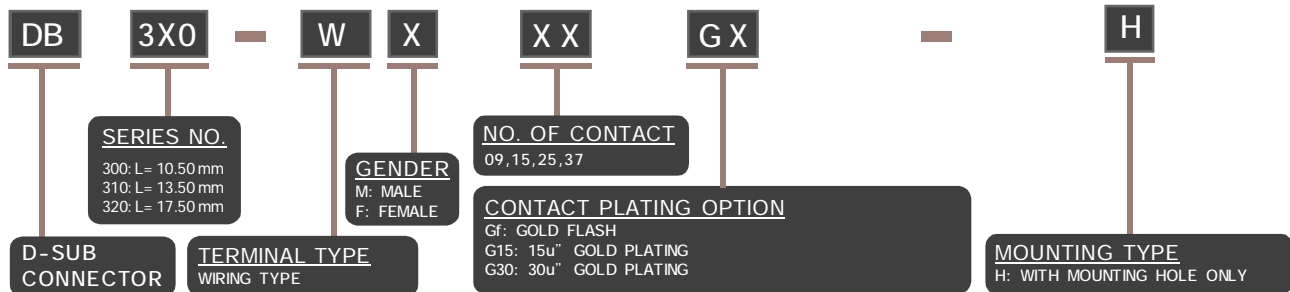

### ELECTRICAL CHARACTERISTIC

CONTACT CURRENT RATING: 1A  
 CONTACT RESISTANCE: 25 mOHM MAX 10 SEC  
 INSULATION RESISTANCE: 5000 MOHM MIN. AT DC 500V  
 DIELECTRIC WITHSTANDING VOLTAGE: AC 1000V 1 MINUTE  
 OPERATING TEMPERATURE:-55°C~ +105°C

### MECHANICAL CHARACTERISTICS

CONTACT INSERTION FORCE: 341 g MAX.  
 CONTACT SEPARATION FORCE: 21 g MIN.

### MATERIALS

INSULATOR: P.B.T UL 94V-0 RATED  
 SHELL: COLD ROLLER STEEL  
 CONTACTS: BRASS

NOTE : SOME SIZES, STYLES AND OPTION ARE NON-STANDARD, NON-CANCELLABLE, NON-RETURNABLE