

MODULAR JACK PRODUCT GUIDE

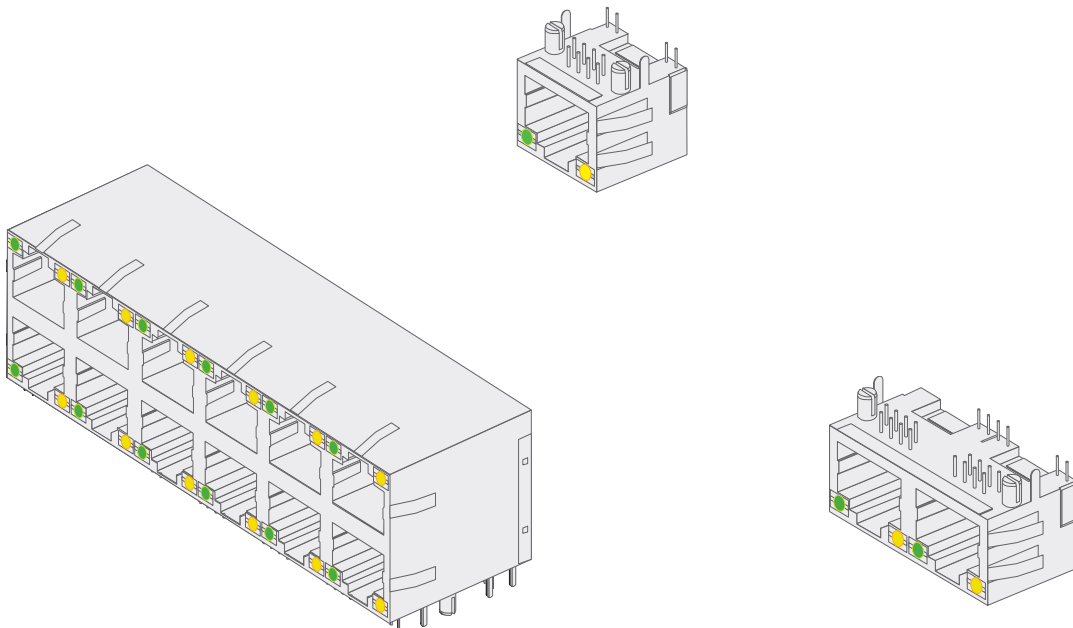

PRODUCT OFFERING:

CAT 5 RJ45, RJ11

OPTIONS:

NON-SHIELDED, FRONT SHIELDED, FULLY SHIELDED
PANEL STOP, GROUNDING TAB, PANEL GROUNDING TAB
R/A SIDE ENTRY, STRAIGHT TOP ENTRY, SMT SIDE ENTRY, BOTTOM ENTRY
INTEGRATED EMI FERRITE
INTERGRATED EMI CIRCUITRY
INTERGRATED LEDs

MMT Machrone

MODULAR JACK PRODUCT GUIDE

MMT Machrone offers a wide range of modular jack products for your Network and Telecommunication applications. From telephone jack to RJ45 mod jack, with various options : shielded, front-shielded, R/A. straight, SMT; with EMI or transformer built-in. Please contact us or check our web site for detail specifications. All parts confirm to FCC rules and regulations part 68, subpart F.

RJ11 - 4P4C, 4P2C, 6P6C, 6P4C, 6P2C

NON-SHIELDED

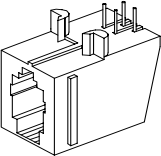
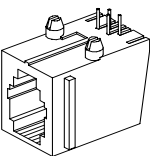
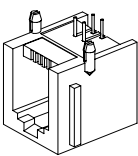
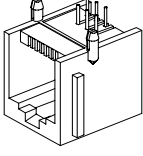
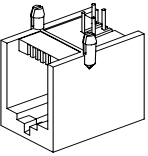
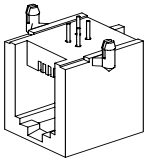
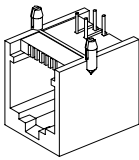
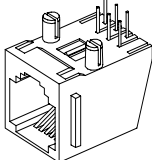
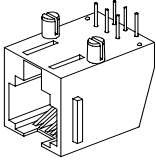
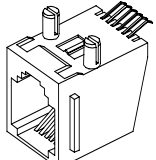
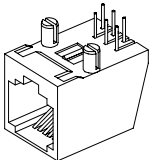
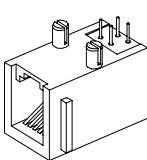
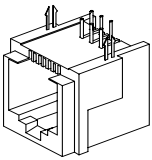
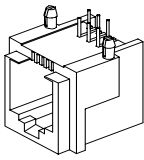
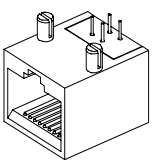
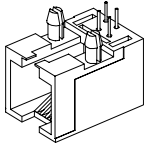
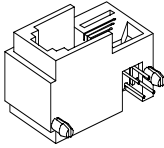
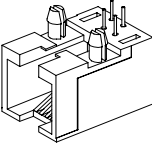
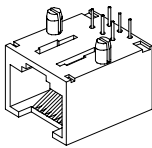
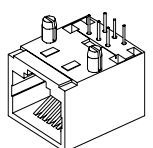
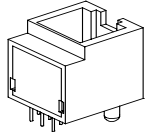
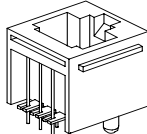
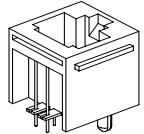
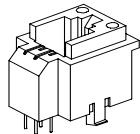
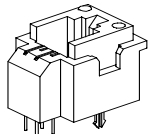
				
R/A, SIDE ENTRY NON-SHIELDED FLANGE OPTION 4P4C, 4P2C 6P6C, 6P4C, 6P2C	R/A, SIDE ENTRY NON-SHIELDED FLANGE OPTION 4P4C, 4P2C 6P6C, 6P4C, 6P2C	R/A, SIDE ENTRY NON-SHIELDED FLANGE OPTION 4P4C, 4P2C	R/A, SIDE ENTRY NON-SHIELDED FLANGE OPTION 6P6C, 6P4C, 6P2C	R/A, SIDE ENTRY NON-SHIELDED 4P4C, 4P2C 6P6C, 6P4C, 6P2C
				
R/A, SIDE ENTRY NON-SHIELDED 4P4C, 4P2C 6P6C, 6P4C, 6P2C	R/A, SIDE ENTRY NON-SHIELDED 4P4C, 4P2C 6P6C, 6P4C, 6P2C	R/A, SIDE ENTRY NON-SHIELDED KEY OPTION FLANGE OPTION 6P6C, 6P4C, 6P2C	R/A, SIDE ENTRY NON-SHIELDED FLANGE OPTION 6P6C, 6P4C, 6P2C	SMT, SIDE ENTRY NON-SHIELDED FLANGE OPTION 6P6C, 6P4C, 6P2C
				
R/A, SIDE ENTRY NON-SHIELDED 6P6C, 6P4C, 6P2C	R/A, SIDE ENTRY NON-SHIELDED FLANGE OPTION 4P4C, 4P2C 6P6C, 6P4C, 6P2C	R/A, SIDE ENTRY NON-SHIELDED 6P6C, 6P4C, 6P2C	R/A, SIDE ENTRY NON-SHIELDED 6P6C, 6P4C, 6P2C	R/A, SIDE ENTRY NON-SHIELDED 4P4C, 4P2C 6P6C, 6P4C, 6P2C
				
R/A, SIDE ENTRY NON-SHIELDED 4P4C, 4P2C 6P6C, 6P4C, 6P2C	DIP, TOP ENTRY NON-SHIELDED 4P4C, 4P2C	R/A, SIDE ENTRY NON-SHIELDED 4P4C, 4P2C 6P6C, 6P4C, 6P2C	R/A, SIDE ENTRY NON-SHIELDED 6P6C, 6P4C, 6P2C	R/A, SIDE ENTRY NON-SHIELDED 6P6C, 6P4C, 6P2C
				
DIP, TOP ENTRY NON-SHIELDED 6P6C, 6P4C, 6P2C	DIP, TOP ENTRY NON-SHIELDED FLANGE OPTION 4P4C, 4P2C 6P6C, 6P4C, 6P2C	DIP, TOP ENTRY NON-SHIELDED FLANGE OPTION 4P4C, 4P2C 6P6C, 6P4C, 6P2C	DIP, TOP ENTRY NON-SHIELDED 4P4C, 4P2C 6P6C, 6P4C, 6P2C	DIP, TOP ENTRY NON-SHIELDED 4P4C, 4P2C 6P6C, 6P4C, 6P2C

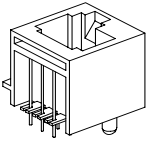
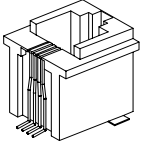
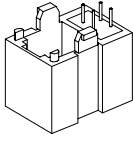
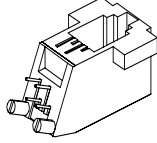
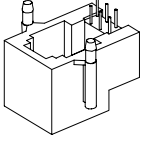
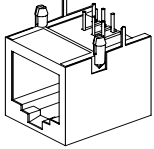
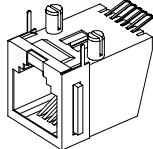
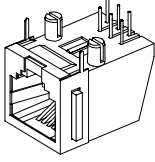
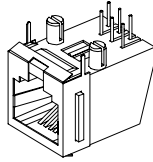
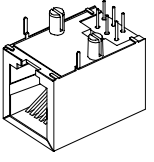
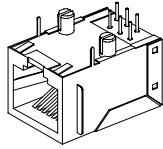
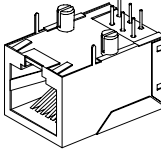
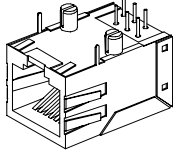
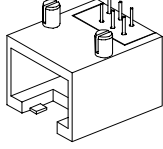
<p>MJK730-P</p> 	<p>MJK739-Rt</p> 	<p>MJK691-P</p> 	<p>MJK664-Pa</p> 	<p>MJK751-P</p> 
<p>DIP, TOP ENTRY NON-SHIELDED 6P6C, 6P4C, 6P2C</p>	<p>SMT, TOP ENTRY NON-SHIELDED 4P4C, 4P2C 6P6C, 6P4C, 6P2C</p>	<p>DIP, BOTTOM ENTRY NON-SHIELDED 4P4C, 4P2C 6P6C, 6P4C, 6P2C</p>	<p>DIP, TOP ENTRY NON-SHIELDED 4P4C, 4P2C</p>	<p>DIP, BOTTOM ENTRY NON-SHIELDED 6P6C, 6P4C, 6P2C</p>
<p><u>RJ11</u> <i>SHIELDED</i></p>				
<p>MJK612-Pa</p> 	<p>MJK628-Rt</p> 	<p>MJK659-Pa</p> 	<p>MJK663-Pa</p> 	<p>MJK740-Pa</p> 
<p>R/A, SIDE ENTRY SHIELDED 6P6C, 6P4C, 6P2C</p>	<p>SMT, SIDE ENTRY FRONT SHIELDED FLANGE OPTION 6P6C, 6P4C, 6P2C</p>	<p>R/A, SIDE ENTRY FRONT SHIELDED FLANGE OPTION 6P6C, 6P4C, 6P2C</p>	<p>R/A, SIDE ENTRY FRONT SHIELDED FLANGE OPTION 6P6C, 6P4C, 6P2C</p>	<p>R/A, SIDE ENTRY SHIELDED -D, -E OPTIONS 6P6C, 6P4C, 6P2C</p>
<p>MJK741-Pa</p> 	<p>MJK741-Pa</p> 	<p>MJK741-Pa</p> 	<p>MJK745-Pa</p> 	
<p>R/A, SIDE ENTRY SHIELDED W/ TABS -B, -D OPTIONS FLANGE OPTION 6P6C, 6P4C, 6P2C</p>	<p>R/A, SIDE ENTRY SHIELDED -B, -D OPTIONS 6P6C, 6P4C, 6P2C</p>	<p>R/A, SIDE ENTRY SHIELDED W/TABS -B, -D OPTIONS 6P6C, 6P4C, 6P2C</p>	<p>R/A, SIDE ENTRY NON-SHIELDED 6P6C, 6P4C, 6P2C</p>	

RJ11 GANG JACK

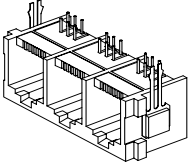
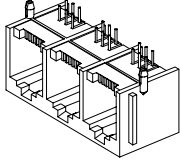
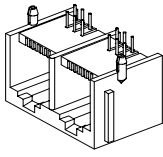
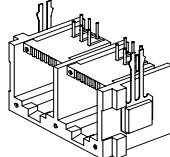
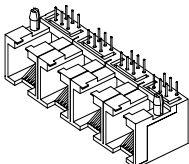
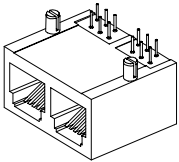
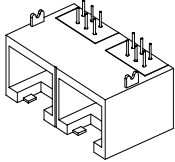
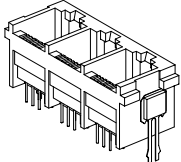
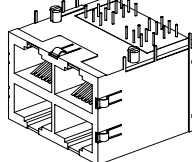
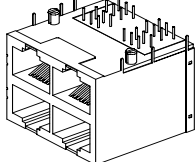
<p>MJK630-Pa</p> 	<p>MJK650-Pa</p> 	<p>MJK666-Pa</p> 	<p>MJK632-Pa</p> 	<p>MJK697-Pa</p> 
<p>R/A, SIDE ENTRY NON-SHIELDED FLANGE OPTION 2, 3, 4, 5, 6, 7, 8 PORTS 6P6C, 6P4C, 6P2C</p>	<p>R/A, SIDE ENTRY NON-SHIELDED FLANGE OPTION 2, 3, 4, 5, 6, 7, 8 PORTS 6P6C, 6P4C, 6P2C</p>	<p>R/A, SIDE ENTRY NON-SHIELDED FLANGE OPTION 6P6C, 6P4C, 6P2C</p>	<p>R/A, SIDE ENTRY NON-SHIELDED FLANGE OPTION 6P6C, 6P4C, 6P2C</p>	<p>R/A, SIDE ENTRY NON-SHIELDED 2, 3, 4, 5, 6, 7, 8 PORTS 6P6C, 6P4C, 6P2C</p>
<p>MJK508-Pa</p> 	<p>MJK745-Pa</p> 	<p>MJK660-P</p> 	<p>MJK731-Pa</p> 	<p>MJK731-Pa</p> 
<p>R/A, SIDE ENTRY NON-SHIELDED 6P6C, 6P4C, 6P2C</p>	<p>R/A, SIDE ENTRY NON-SHIELDED METAL OPTION 6P6C, 6P4C, 6P2C</p>	<p>DIP, TOP ENTRY NON-SHIELDED FLANGE OPTION 2, 3, 4, 5, 6, 7, 8 PORTS 6P6C, 6P4C, 6P2C</p>	<p>R/A, SIDE ENTRY SHIELDED W/TABS STACK OPTION 2, 4, 6, 8, 12, 16 PORTS 6P6C, 6P4C, 6P2C</p>	<p>R/A, SIDE ENTRY SHIELDED STACK OPTION 2, 4, 6, 8, 12, 16 PORTS 6P6C, 6P4C, 6P2C</p>

MMT Machrone

MODULAR JACK PRODUCT GUIDE

RJ45 - 10P10C, 10P8C, 8P8C NON-SHIELDED

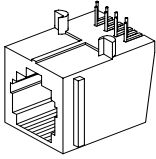
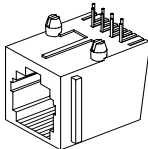
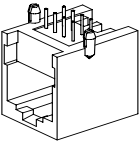
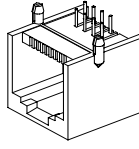
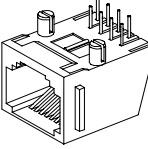
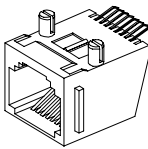
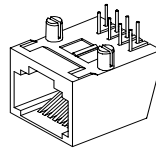
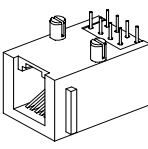
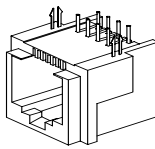
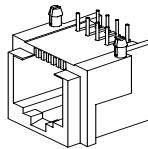
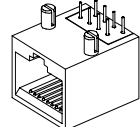
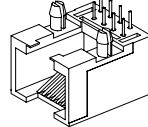
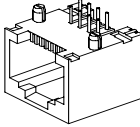
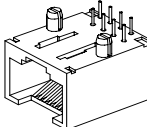
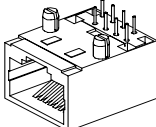
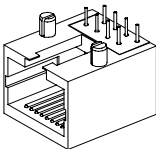
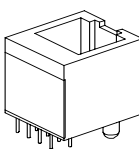
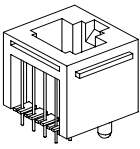
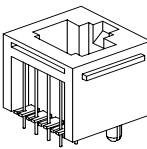
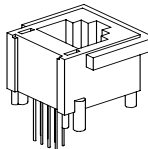
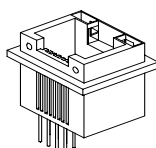
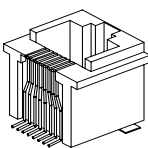
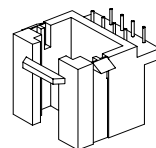
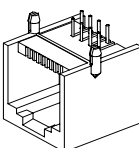
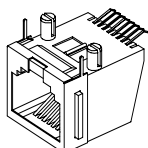
MJK601-Pa	MJK602-Pa	MJK608-Pa	MJK612-Pa	MJK619-Pa
				
R/A, SIDE ENTRY NON-SHIELDED FLANGE OPTION 8P8C	R/A, SIDE ENTRY NON-SHIELDED FLANGE OPTION 8P8C	R/A, SIDE ENTRY NON-SHIELDED FLANGE OPTION 8P8C	R/A, SIDE ENTRY NON-SHIELDED FLANGE OPTION 8P8C 10P10C, 10P8C	R/A, SIDE ENTRY NON-SHIELDED FLANGE OPTION 8P8C 10P10C, 10P8C
MJK629-Rt	MJK631-Pa	MJK636-Pa	MJK667-Pa	MJK676-Pa
				
SMT, SIDE ENTRY NON-SHIELDED FLANGE OPTION 8P8C	R/A, SIDE ENTRY NON-SHIELDED 8P8C 10P10C, 10P8C	R/A, SIDE ENTRY NON-SHIELDED FLANGE OPTION 8P8C	R/A, SIDE ENTRY NON-SHIELDED 8P8C	R/A, SIDE ENTRY NON-SHIELDED 8P8C
MJK686-Pa	MJK694-Pa	MJK714-Pa	MJK721-Pa	MJK740-Pa
				
R/A, SIDE ENTRY NON-SHIELDED 8P8C	R/A, SIDE ENTRY NON-SHIELDED KEY OPTION 8P8C	R/A, SIDE ENTRY NON-SHIELDED 8P8C	R/A, SIDE ENTRY NON-SHIELDED 8P8C	R/A, SIDE ENTRY NON-SHIELDED 8P8C 10P10C, 10P8C
MJK743-Pa	MJK646-Pa	MJK605-P	MJK607-P	MJK698-P
				
R/A, SIDE ENTRY NON-SHIELDED 8P8C	DIP, TOP ENTRY NON-SHIELDED 8P8C	DIP, TOP ENTRY NON-SHIELDED KEY OPTION FLANGE OPTION 8P8C 10P10C, 10P8C	DIP, TOP ENTRY NON-SHIELDED KEY OPTION FLANGE OPTION 8P8C	DIP, TOP ENTRY NON-SHIELDED 8P8C
MJK729-P	MJK739-Rt	MJK717-P	MJK612-Pa	MJK628-Rt
				
DIP, TOP ENTRY NON-SHIELDED 8P8C	SMT, TOP ENTRY NON-SHIELDED KEY OPTION 8P8C	DIP, BOTTOM ENTRY NON-SHIELDED 8P8C	R/A, SIDE ENTRY SHIELDED 8P8C 10P10C, 10P8C	SMT, SIDE ENTRY FRONT SHIELDED FLANGE OPTION 8P8C 10P10C, 10P8C

MMT Machrone

MODULAR JACK PRODUCT GUIDE

RJ45

SHIELDED

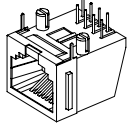
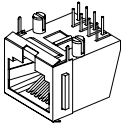
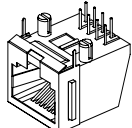
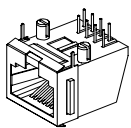
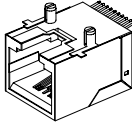
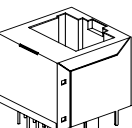
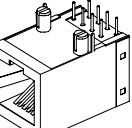
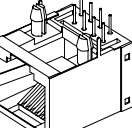
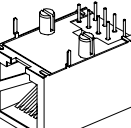
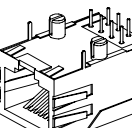
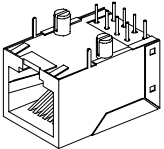
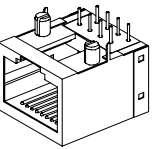
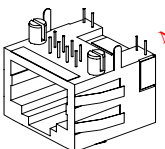
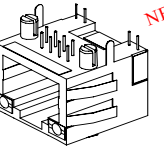
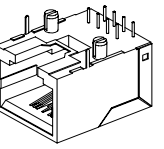
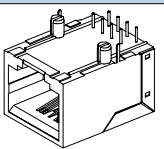
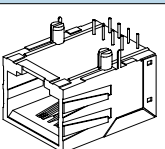
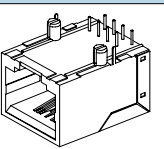
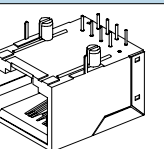
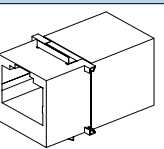
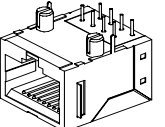
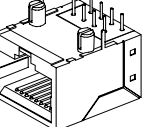
MJK659-Pa	MJK661-Pa	MJK663-Pa	MJK668-Pa	MJK627-Rt
				
R/A, SIDE ENTRY FRONT SHIELDED FLANGE OPTION 8P8C 10P10C, 10P8C	R/A, SIDE ENTRY FRONT SHIELDED FLANGE OPTION 8P8C	R/A, SIDE ENTRY FRONT SHIELDED FLANGE OPTION 8P8C 10P10C, 10P8C	R/A, SIDE ENTRY FRONT SHIELDED FLANGE OPTION KEY OPTION 8P8C	DIP, SIDE ENTRY SHIELDED -E OPTION 10P10C, 10P8C
MJK647-P	MJK686-Pa	MJK694-Pa	MJK740-Pa	MJK741-Pa
				
DIP, TOP ENTRY SHIELDED -1, -2 OPTIONS 8P8C	R/A, SIDE ENTRY SHIELDED -D, -E OPTIONS 8P8C	R/A, SIDE ENTRY SHIELDED -D, -E OPTIONS 8P8C	R/A, SIDE ENTRY SHIELDED -D, -E OPTIONS 8P8C	R/A, SIDE ENTRY SHIELDED W/ TABS -B, -D OPTIONS 8P8C
MJK741-Pa	MJK743-Pa	MJK188-Pa	MJK 188-Pa	MJK004-Pa
				
R/A, SIDE ENTRY SHIELDED -B, -D OPTIONS 8P8C	R/A, SIDE ENTRY SHIELDED -D, -E OPTIONS 8P8C	R/A, SIDE ENTRY SHIELDED W/ TABS 8P8C	R/A, SIDE ENTRY SHIELDED W/ TABS 8P8C	R/A, SIDE ENTRY SHIELDED, LOW PROFILE 8P8C
MJK988-Pa	MJK747-Pa	MJK747-Pa	MJK908-Pa	MJK101-P
				
R/A, SIDE ENTRY SHIELDED 8P8C	R/A, SIDE ENTRY SHIELDED W/ TABS -D, -E OPTIONS 8P8C	R/A, SIDE ENTRY SHIELDED -D, -E OPTIONS 8P8C	R/A, SIDE ENTRY SHIELDED -B, -D OPTIONS 10P10C, 10P8C	R/A, SIDE ENTRY SHIELDED 8P8C <i>COUPLER/ADAPTER</i>
MJK648-Pa	MJK648-Pa			
				
R/A, SIDE ENTRY SHIELDED W/ TABS -D, -E OPTIONS 8P8C	R/A, SIDE ENTRY SHIELDED -D, -E OPTIONS 8P8C			

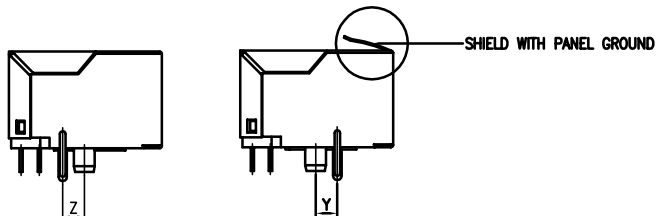

	Y DIMENSION	Z DIMENSION
-A	4.56 mm	-----
-B	3.65 mm	-----
-E	3.05 mm	-----
-C	-----	3.65 mm
-D	-----	3.05 mm
-G	2.97 mm	-----

MMT Machrone

MODULAR JACK PRODUCT GUIDE

RJ45 GANG JACK

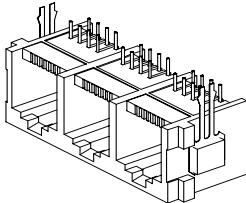
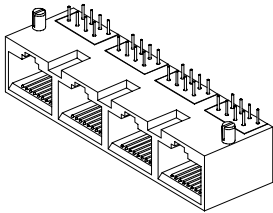
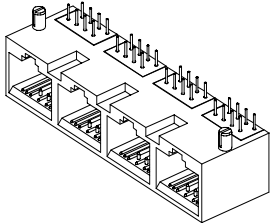
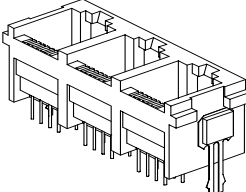
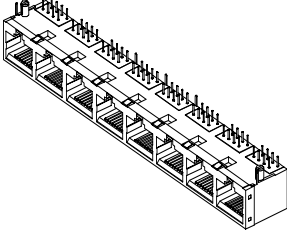
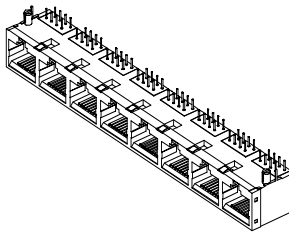
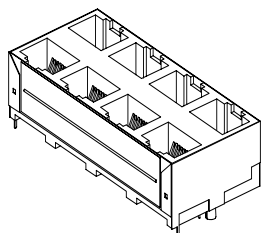
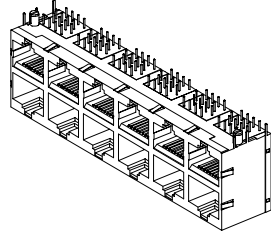
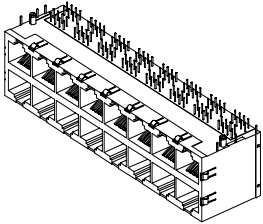
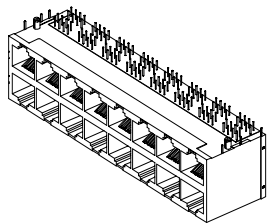
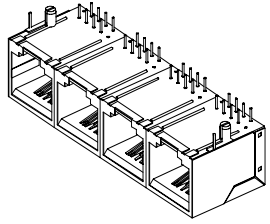
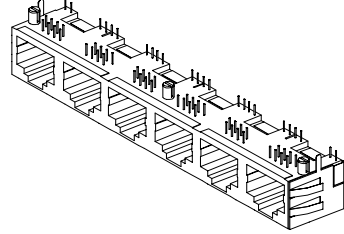
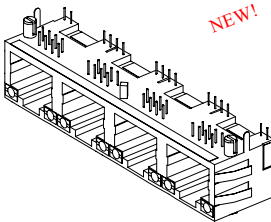
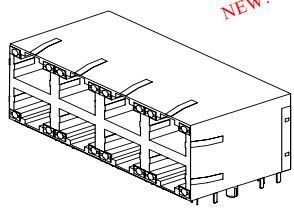
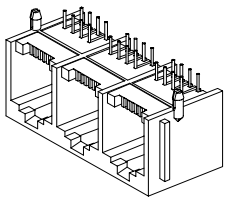
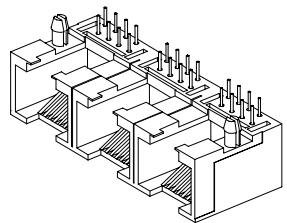
<p style="text-align: center;">MJK630-Pa</p> 	<p style="text-align: center;">MJK670-Pa</p> 	<p style="text-align: center;">MJK749-Pa</p> 	<p style="text-align: center;">MJK660-P</p> 
<p>R/A, SIDE ENTRY NON-SHIELDED FLANGE OPTION 2, 3, 4 PORTS 8P8C</p>	<p>R/A, SIDE ENTRY NON-SHIELDED 2, 3, 4, 5, 6, 7, 8, 9, 10, 11, 12 PORTS 8P8C</p>	<p>R/A, SIDE ENTRY NON-SHIELDED 2, 3, 4, 5, 6, 7, 8, 9, 10, 11, 12 PORTS 8P8C</p>	<p>DIP, TOP ENTRY NON-SHIELDED FLANGE OPTION 2, 3, 4 PORTS 8P8C</p>
<p style="text-align: center;">MJK648-Pa</p> 	<p style="text-align: center;">MJK648-Pa</p> 	<p style="text-align: center;">MJK708-P</p> 	<p style="text-align: center;">MJK732-Pa</p> 
<p>R/A, SIDE ENTRY SHIELDED W/TABS -E, -D OPTIONS 2, 4, 6, 8 PORTS 8P8C</p>	<p>R/A, SIDE ENTRY SHIELDED -E, -D OPTIONS 2, 4, 6, 8 PORTS 8P8C</p>	<p>DIP, TOP ENTRY SHIELDED STACK OPTION 2, 4, 6, 8 PORTS 8P8C</p>	<p>R/A, SIDE ENTRY SHIELDED W/TABS STACK OPTION 2, 4, 6, 8, 12 PORTS 8P8C</p>
<p style="text-align: center;">MJK731-Pa</p> 	<p style="text-align: center;">MJK731-Pa</p> 	<p style="text-align: center;">MJK908-Pa</p> 	<p style="text-align: center;">MJK188-Pa</p> 
<p>R/A, SIDE ENTRY SHIELDED W/TABS STACK OPTION 2, 4, 6, 8, 12, 16 PORTS 8P8C</p>	<p>R/A, SIDE ENTRY SHIELDED STACK OPTION 2, 4, 6, 8, 12, 16 PORTS 8P8C</p>	<p>R/A, SIDE ENTRY SHIELDED GROUNDING TAB OPTION 2, 4, 6, 8 PORTS 10P10C, 10P8C</p>	<p>R/A, SIDE ENTRY SHIELDED W/TABS 2, 4, 6, 8 PORTS 8P8C</p>
<p style="text-align: center;">MJK188-Pa</p> 	<p style="text-align: center;">MJK188-Pa</p> 	<p style="text-align: center;">MJK650-Pa</p> 	<p style="text-align: center;">MJK697-Pa</p> 
<p>R/A, SIDE ENTRY SHIELDED W/ TABS LED OPTION 2, 4, 6, 8 PORTS 8P8C</p>	<p>R/A, SIDE ENTRY W/ TABS STACK OPTION LED OPTION 2,4,6,8, 12 PORTS 8P8C</p>	<p>R/A, SIDE ENTRY NON-SHIELDED FLANGE OPTION 2, 3, 4, 5, 6, 7, 8 PORTS 8P8C</p>	<p>R/A, SIDE ENTRY NON-SHIELDED 2, 3, 4, 5, 6, 7, 8, PORTS 8P8C</p>